

I/O Controller 2 MANUAL



Safety information

The device complies with regulations and industrial standards in force in the Czech Republic and the European Union. The device has been tested and is supplied in working order. To keep the device in this condition, it is necessary to adhere to the following safety and maintenance instructions.

The device must not be used in particular under any of the following conditions:

- The device is noticeably damaged
- The device does not function properly
- Unfastened parts can move inside the device
- The device has been exposed to moisture or rain
- The device has been serviced by unauthorized personnel
- The power adapter or power supply cable are noticeably damaged

The manufacturer warrants the device only if it is powered by the supplied power adapter or an approved power supply.

I/O Controller 2

Ethernet – RS-232/485 + inputs and outputs

I/O Controller 2 is an Ethernet-enabled device with 8 digital inputs, 8 digital outputs and a RS-232/485 serial interface.

All interfaces are accessible over TCP/IP using a M2M protocol.

Two devices can be connected against each other (Box-2-Box mode) in order to extend the digital and RS232 signals over the computer network.



Basic features

- **1x full RS-232 or RS-485** serial port accessible over the Ethernet.
- The remote port can be controlled with a **virtual driver for Windows** just like, for example, **COM 5** (a Windows XP / Vista / Windows 7 / Server 2003 / Server 2008 / x64 driver is available free of charge). Compatible with RFC2217.
- 100 Mbps Ethernet interface – 100BASE-Tx, RJ 45
- Support for TCP/IP terminal, TELNET – NVT type (*Network Virtual Terminal*)
- **Two devices** can „tunnel“ the serial port, 8 inputs and 8 outputs over the Ethernet
- **Web-based interface for configuration**
- Wide range of supported **serial interface** parameters:
 - Communication speed configurable from 300...115200 Bd
 - Handshake (CTS/RTS, Xon/Xoff, none)
 - Full serial port (Cannon DB9M - Rx, Tx, CTS, RTS, DSR, DTR, RI, CD, GND)
 - Support for 7th to 9th parity bit (9th parity bit transferred over the Ethernet)
- SDK (Software Development Kit) is available for the device with examples for MS Visual Basic, Delphi, Borland C++, JAVA, PHP and more

Technical specifications

| RS-232 serial port | |
|--|---|
| + Data bits | 7 or 8 or 9 |
| + Stop bits, parity | 1 or 2, None / Odd / Even / Mark / Space parity |
| + Baudrates | 50..115.2 kBd – entire range |
| + Data flow control | XON/XOFF, CTS/RTS, None |
| + Interface | 1x DB9M (RxD, TxD, CTS, RTS, DSR, DTR, RI, CD, GND) |
| + Implemented RS-232 signals | RxD, TxD, CTS, RTS, DSR, DTR, RI, CD |
| RS-485 serial port | |
| + Termination | None (We recommend external termination 120-470Ω) |
| + Isolation | RS-485 line not optocoupled to the device's power supply - electrically isolated RS-232/485 to Ethernet (1000 V) |
| Digital inputs & outputs | |
| + Input type | Dry contact input |
| + Logic LOW voltage | 0 .. 3V |
| + Log. HIGH voltage threshold / "on" current | from <u>5V / 5mA</u> to <u>20V / 25mA</u> |
| + Max. input voltage and current | up to 40V / 50mA / 1 second |
| + Isolation Voltage | max. 50V to power supply |
| + Sampling period | 10 ms |
| + SW control of inputs and outputs | Inputs and Outputs controlled over a NVT-based M2M protocol (extended RFC2217) – short 7-byte binary commands over TCP/IP |
| + Output type | Darlington transistors with common emitter, suppression diodes max. 50V, max. 500mA / 1 output and max. 1500mA / all 8 outputs |
| Ethernet port | |
| + Interface | RJ45 100BASE-T / 100 Mbit/s |
| + Compatibility | Ethernet: Version 2.0/IEEE 802.3 |
| + Supported protocols | IP: ARP, TCP + NVT (Network Virtual Terminal) |
| + TCP connection closing | Data – 5s timeout (with NVT – ACK/NOP support) |
| Physical parameters & Environment | |
| + Temperature & humidity | Operating: 0 – 65 °C (32 – 149 °F) Storage: -10 to 85°C (14 to 185°F), humidity 5 to 95 % |
| + Power supply requirements | 8-30V / Max. device current consumption 200 mA DC |
| | - barrel (coaxial) power connector, GND on the shield |
| + Dimensions / Weight | 120 x 94 x 25 [mm] (H x W x D) / 260 g |

*Note: This parameter table is only indicative.
For a valid table, see the specifications for the particular device model.*

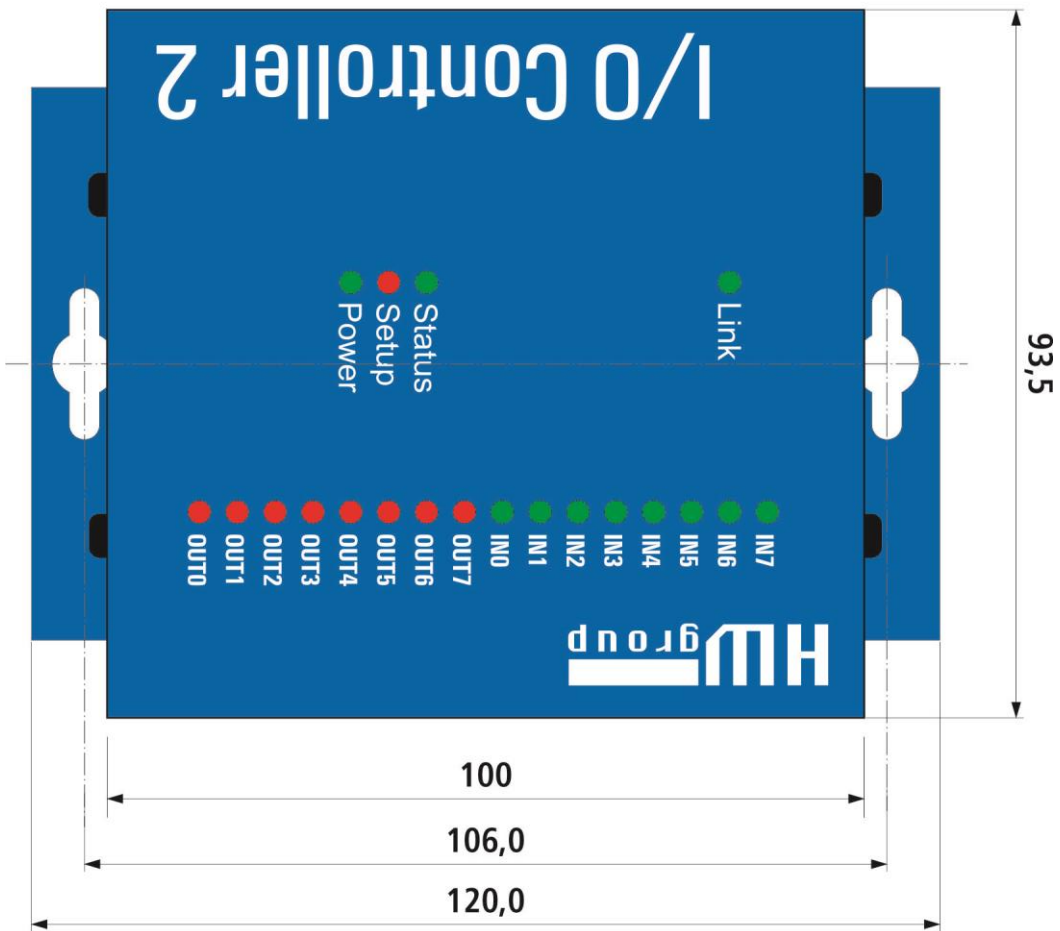
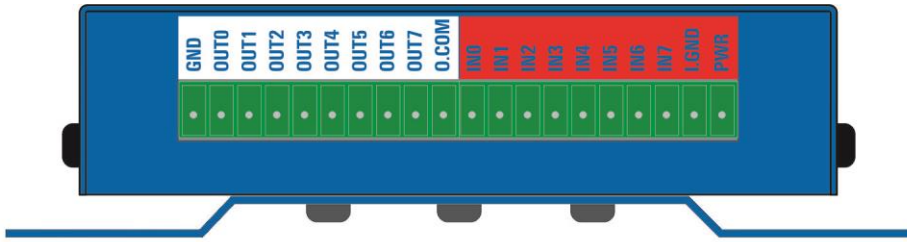

Connectors

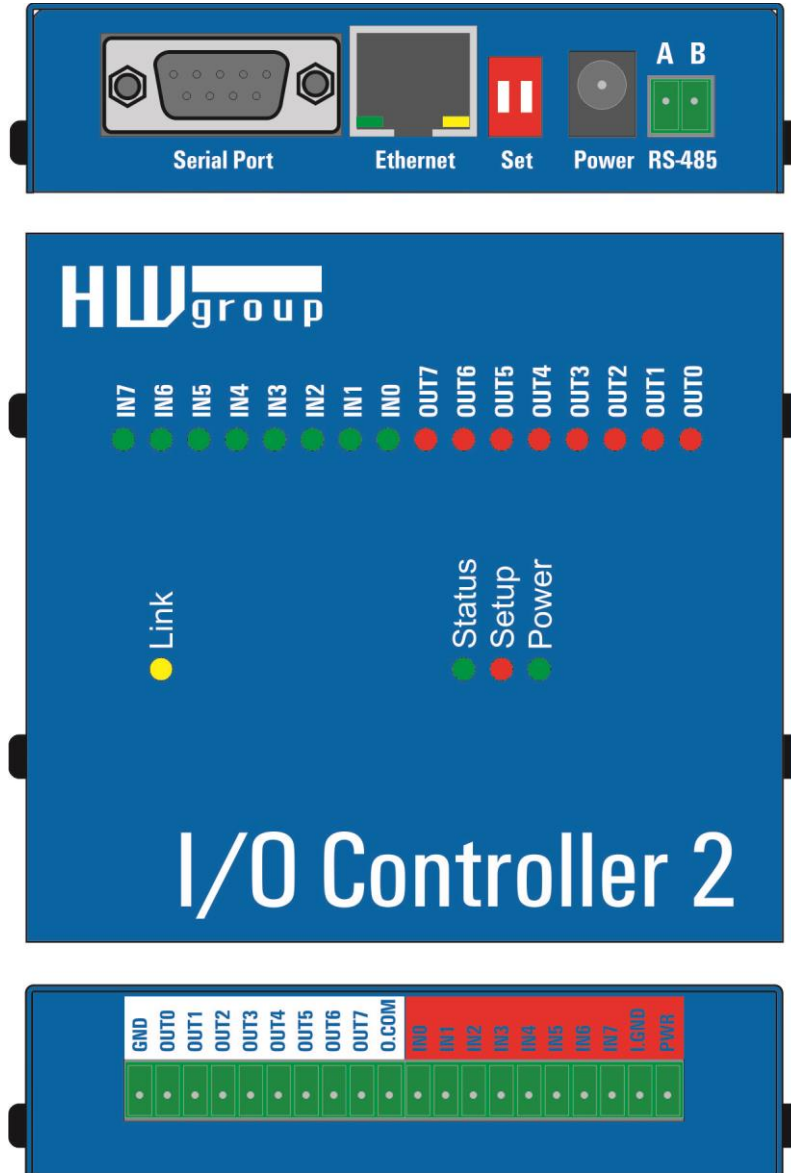

Connector pinout

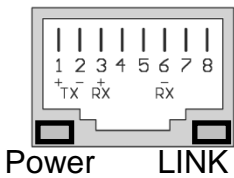

| RS-485 Port | |
|-------------|---------|
| Pin | Signal |
| A | + (A>B) |
| B | - |

| RS-232 Port | |
|-------------|--------|
| Pin | Signal |
| 1 <- | CD |
| 2 <- | RxD |
| 3 -> | TxD |
| 4 -> | DTR |
| 5 -- | GND |
| 6 <- | DSR |
| 7 -> | RTS |
| 8 <- | CTS |
| 9 <- | RI |

Cannon 9 - Male

| DIP 1 | DIP 2 | Function |
|-------|-------|---|
| ON | OFF | RS-232 Setup mode (9600 8N1) <i>Ethernet is disabled</i> |
| OFF | OFF | Serial port in the RS-232 mode |
| OFF | ON | Serial port in the RS-485 mode <i>check the &R and &H parameters (recommended: &R3 &H1)</i> |

LEDs:

Power – green External power connected

LINK – amber Ethernet interface activity

Status – green Device starting up, firmware upgrade

Setup – red Device in serial Setup mode

INx – green Input x is closed

OUTx – red Output x is closed

Digital Inputs & Outputs wiring

- **GND** – device ground.
- **PWR** – device power (max. 200 mA).
The device can be powered from barrel power connector (front panel) or from the I/O connector PWR + GND pins (200 mA internal fuse = suitable only for testing purposes).
- **I.GND** – common ground for optocouplers.
- **I.0 to I.7 - 8 optocoupled inputs 5-20V**
All 8 inputs are realized using common ground optocouplers (I.GND pin). The pins can then be controlled using the contacts together with the POWER pin, which has the power adaptor voltage (**connect I.GND with GND**).

Warning: The digital input voltage range is 5 -20V, but be careful for max total current through I.GND pin which is 200mA for all digital inputs (cca 25 mA per single Digital Input).

- **O.COM** (Common) – Overvoltage output connected to the plus pole of the power source. This can be useful when you want to control a relay from this output.
- **O.0 to O.7 - 8 open collector outputs, with common diode overvoltage protection.**
The outputs are realized using 8 open collector transistors. Two outputs are internally connected to a relay, which contacts are also led out to the device's connector. The protecting diodes are connected to the "common" pin, which should be connected to the plus pole of the next device (for example a relay). This way the pins can be protected against load peaks.

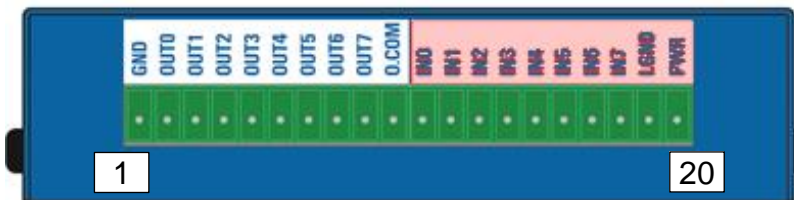

| | PIN | Description | |
|------------|-------|------------------------|----------------------|
| 8x INPUTS | GND | Ground | 1 |
| | OUT0 | Output transistor 0 | 2 |
| | OUT1 | Output transistor 1 | 3 |
| | OUT2 | Output transistor 2 | 4 |
| | OUT3 | Output transistor 3 | 5 |
| | OUT4 | Output transistor 4 | 6 |
| | OUT5 | Output transistor 5 | 7 |
| | OUT6 | Output transistor 6 | 8 |
| | OUT7 | Output transistor 7 | 9 |
| | O.COM | Common wheeling diodes | 10 |
| 8x OUTPUTS | IN0 | Input 0 (5-15V) | 11 |
| | IN1 | Input 1 (5-15V) | 12 |
| | IN2 | Input 2 (5-15V) | 13 |
| | IN3 | Input 3 (5-15V) | 14 |
| | IN4 | Input 4 (5-15V) | 15 |
| | IN5 | Input 5 (5-15V) | 16 |
| | IN6 | Input 6 (5-15V) | 17 |
| | IN7 | Input 7 (5-15V) | 18 |
| | | I.GND | Opto-couplers ground |
| | PWR | Ext. power supply | 20 |

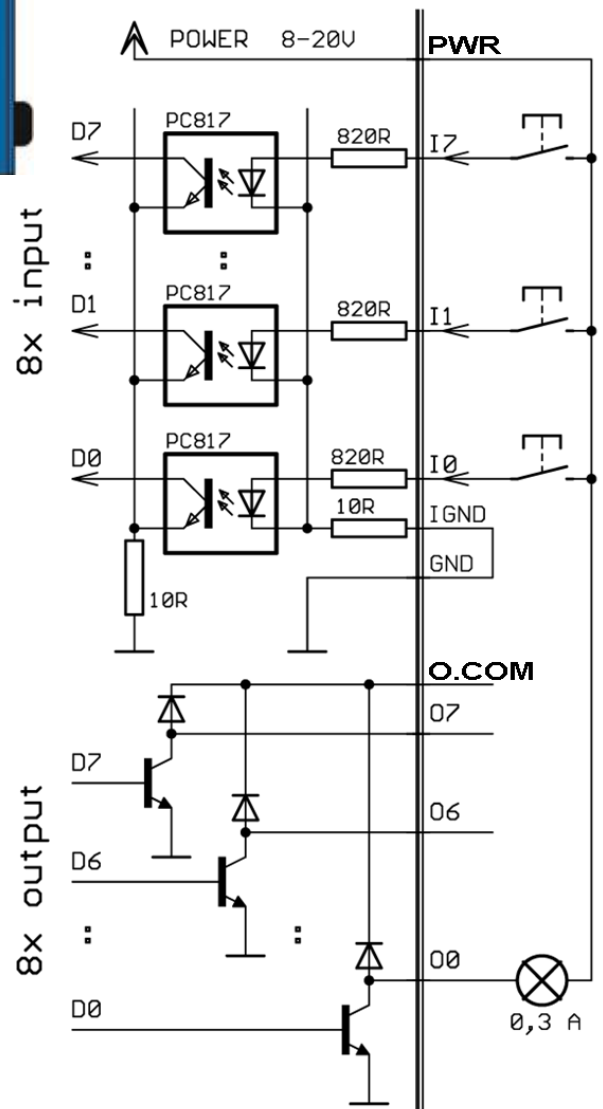

Quick SETUP

Connecting the cables

- Connect the supplied power adapter to an electrical outlet.
- Set **DIP1** and **DIP2** to **OFF**.
- Connect the device to the Ethernet.
- Connect the power adapter to the power connector at the device.
- If the power is OK, the green **Power** LED lights up.
- If the Ethernet connection works properly, the **LINK** LED lights up, and then flashes whenever data transfer takes place (activity indication).

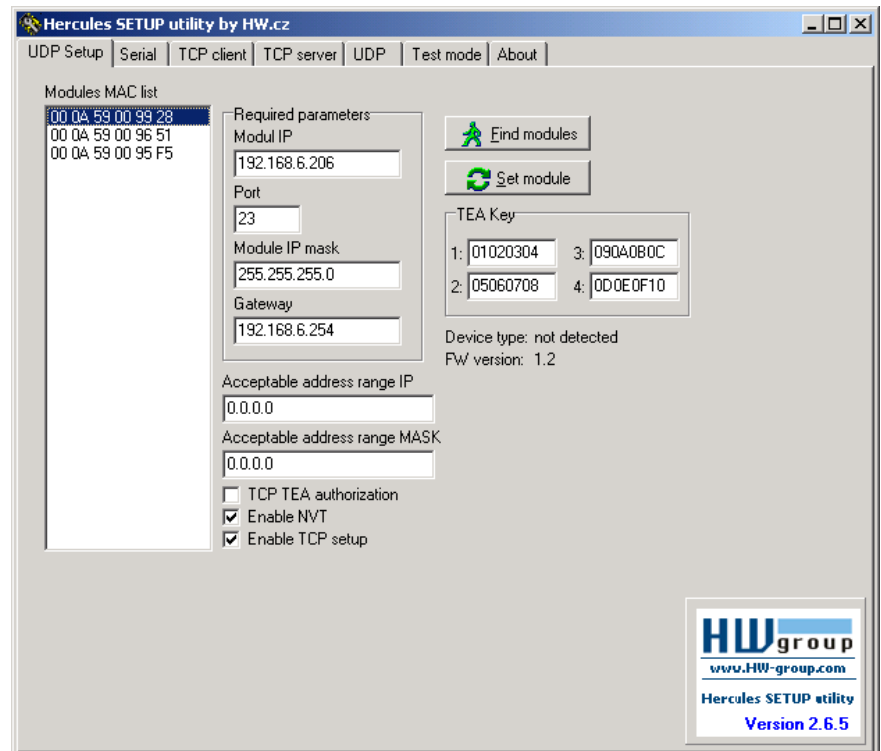

Configuring the IP address

- Start the "**HerculesSetup.exe**" utility. It is available on the DVD (included in the "set" package) or for free download at www.HW-group.com.
- In the "**UDP Setup**" tab, click "**Find modules**". The MAC address of the device appears in the left column. Click the MAC address and set the required parameters (at least the IP address, mask and gateway).
- Make sure that "Enable TCP Setup" is checked. Click "Set module" to save the parameters to the device.
- You have now configured the IP address and other networking parameters and you can work with the device.

MAC address not visible in the list?

LINK LED did not light up or the device does not respond? Please double check the following.

- Does your Ethernet network support 10 Mbps devices?
- Are you using a correct TP cable (straight-wired TP Patch when connecting to an Ethernet switch, crossover cable when connecting to a PC)?
- Check the DIP switch settings (all should be OFF).
- Check your power adapter, make sure the Power LED is on.
- Check the firewall settings at your PC.

Configuring the device over WWW

In the UDP Setup tab, click the correct MAC address and press **Open in the WEB browser**.

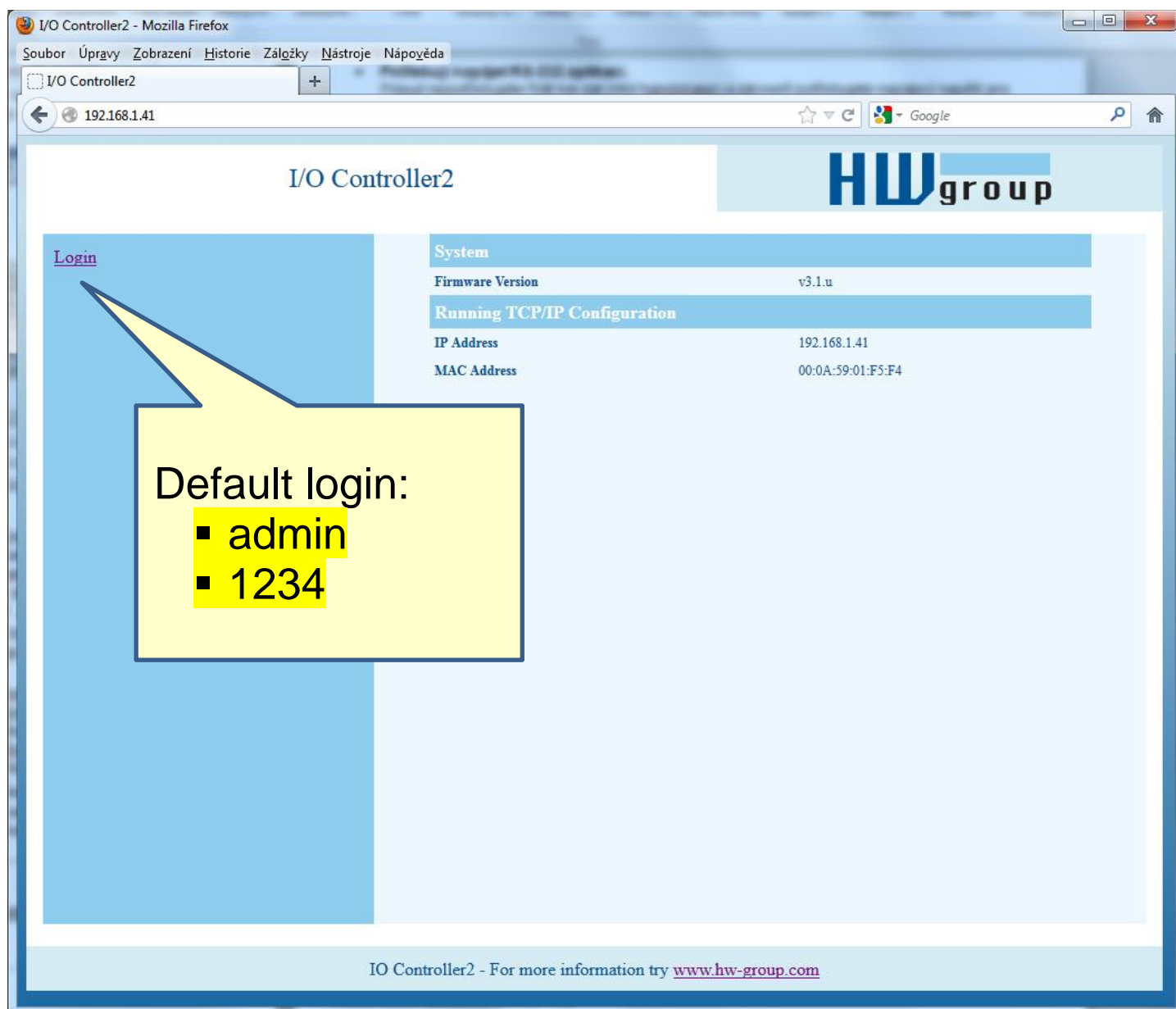

You need to log in to access the configuration.
The default password is “admin” + “1234”

Setting up the device using TCP Setup

- Change to the “**TCP Client**” tab and enter the configured IP address. Set the **TCP Port** to **99**.
- Click “**Connect**”. The listing on the left displays the “**WEB51>**” prompt. Click inside this pane and press ENTER. The window displays the current configuration.
- To set a parameter, enter the corresponding letter and the desired value (for example “**I192.168.6.8**” to set the device IP address). To show the help for a command, enter the command and a question mark, and press ENTER – for example, “**I? <Enter>**”. All the settings are described in detail later in this manual.
- After setting the parameters, use **R** for **Reboot** and press “**Disconnect**” to disconnect from the device. The device restarts.
- **Note:** TCP Setup can be disabled with the “**Enable TCP setup**” option. When unchecked, the device refuses connections to port 99.

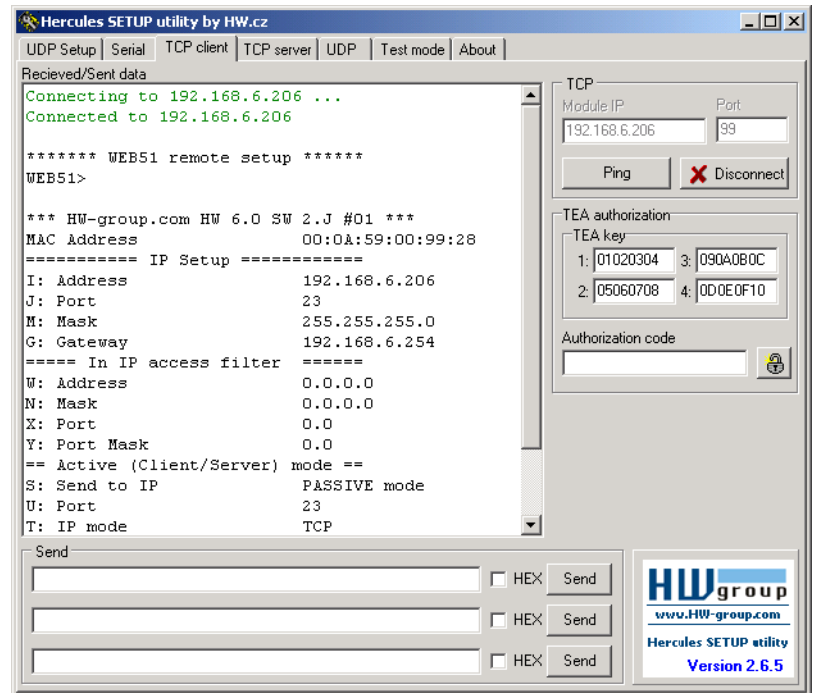

Setting up the device using a RS-232 terminal

If you do not have Windows or our Hercules utility available, you can set up the device over RS-232 using any terminal.

- Set **DIP1 = ON**, **DIP2 = OFF**.
- Connect RS-232 (port 1) to a PC using the supplied **LapLink** cable.
- Open your favorite terminal program (e.g. Hyperterminal), choose the correct serial port and configure it to **9600 8N1**.
- Connect the power adapter to the electrical outlet and to the device.
- If the power is OK, the green **Power** LED lights up.
- If the serial cable and terminal program are working, the text menu for configuring the device appears.

Continue by following the steps as in the previous case.

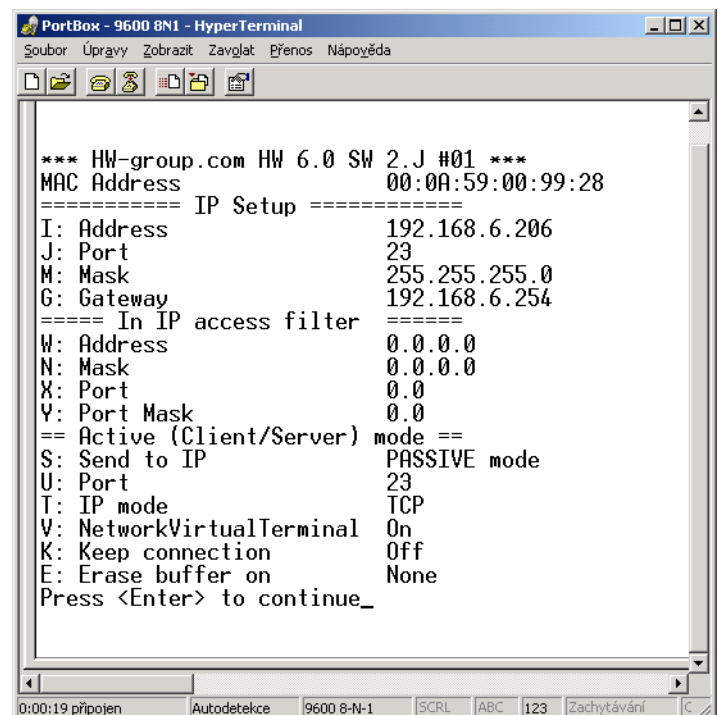

Quick control of inputs and outputs

This chapter shows how to read a digital input and set a digital output to a desired value. We assume that a test board supplied with device samples is used.

The following assumes that you know how to enter the setup mode (RS-232 Setup or TCP Setup at port 99). The respective steps were described in the previous sections.

- Set **DIP1 = OFF**, **DIP2 = OFF**, connect the test board to the connector and turn on the device.
- Change to the “**UDP Setup**” tab, find the devices, and make sure that the “**Enable TCP setup**” and “**Enable NVT**” options in the lower left-hand portion next to the MAC list are checked for the respective device . If not, check both options and save your settings to the device.
- Double-click the IP address in the “UDP Setup” tab and change to the “**Test mode**” tab. The double-click action should transfer the IP address and port to the Test tab. If this does not happen, enter the values manually.
- Click “**Connect**”. The listing at the left-hand side displays Connecting, followed by one or three NVT commands in the received data. All recognized commands are displayed in blue.

The image shows the listing and the configuration options of the Hercules utility. To invoke the menu, right-click inside the receiving pane or the transmitting pane.

- At this point, click “**Read**” in the lower right-hand corner to read the inputs (8 switches at the test board). Input states are indicated by the virtual LEDs D0 to D7, respectively. States can be inverted with the “LED polarity” option.
- The D0 – D7 checkboxes set the corresponding outputs. The first command sets all outputs to defined states, subsequent commands set individual bits. Outputs can be again inverted using the “Inversed” option. The “Write together” option does not send commands immediately when an output is selected; instead, outputs are set after clicking “**Write**”.
- When “Show I/O commands” is enabled, notice the I/O Controller control sequences in the incoming and outgoing panels. This makes it easy to test the commands.
- Enter “FF F6” to the Send lines at the bottom, check HEX and click the corresponding Send button to send this command. The receiving pane should show “<WEB51 HW 4.7 SW 2.J SN 00A608 #01>” or something similar. You have just sent your first NVT command requesting “Are You There” identification, and the I/O Controller replied with its HW and SW version. The SN number consists of the last three bytes of the MAC address.
- If the TCP connection is closed while working (red message “**Connection refused by remote host**”), click “Connect” to reconnect. The module uses a rather short timeout (50 s) for manual control.

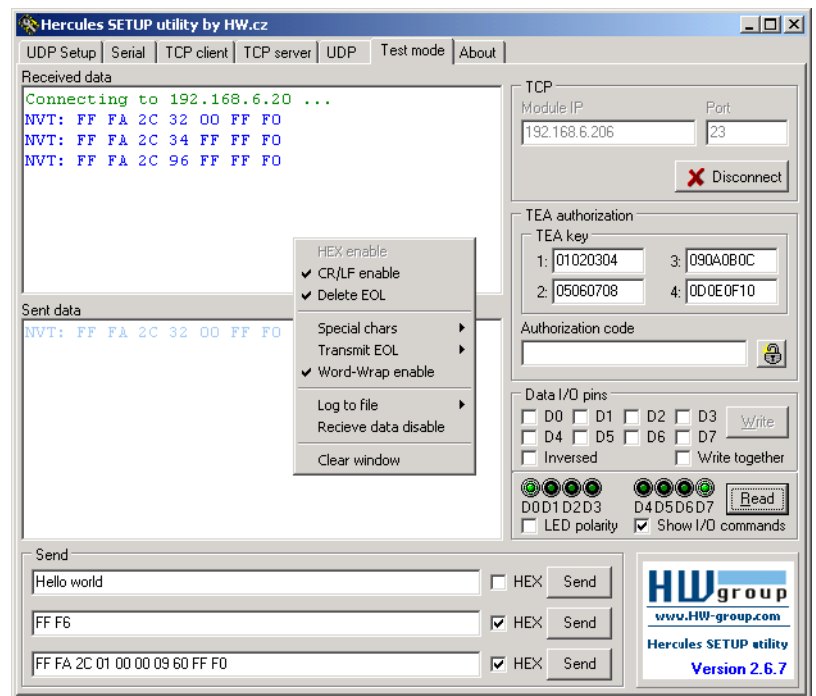

Setting up the device – Frequently Asked Questions

- **Ethernet no longer works but LINK is lit.**
Perhaps the device was left in the “RS-232 Setup” mode that is activated by setting **DIP1** = ON? In this mode, the Ethernet does not respond. Set **DIP1** = OFF and restart the device by disconnecting the power supply for at least 3 seconds.
- **RS-485 communication does not work.**
Make sure that **termination resistors** (120 – 470 Ohms) are present at the line or at the connector.
- When using a RS485 converter, configure **&I1** or **&I2** and remember to turn on HALF DUPLEX using **&H1**.
- **I need to supply power to a RS-232 application.**
If you don't need to control data flow (HW handshake) but need to power a device connected to the serial port (max. 5 – 10 mA), power your application from the RTS output (pin 7 at the RS-232 connector). The **&R0** parameter (&R: RS485/RS422 control) in the setup connects approximately +8 V to +12 V to this pin.
- **Digital inputs and outputs cannot be controlled. RS-232 data work fine.**
Most likely, “NVT” is disabled. Check this at the “UDP Setup” tab in the Hercules utility, in the TCP Setup, or in the RS-232 Setup.
- **5-second timeout is too short to work with, is it possible to do something about it?**
Yes, enable “Keep connection” in the Setup. I/O Controller then sends a command every 6 seconds that appears as “NVT: NOP” in the receiving pane, and the connection does not timeout.

HW VSP – virtual serial port

Virtual serial port driver is a software tool that adds a virtual serial port (e.g. COM5) to the operating system and redirects data from this port via the Ethernet network to another hardware interface.



- The driver works in Windows XP, Vista, Windows 7, Windows 2003 Server, Windows 2008 Server, including 64-bit versions.
- If the device supports RFC 2217 (NVT), you can set the remote serial port parameters (speed, parity, stop bits).
- The communication can be recorded to a LOG file for easier debugging.
- It is possible to create multiple virtual serial ports on a single computer (COM5, COM6, COM7) by starting VSP.EXE from the command line with appropriate parameters.

Using HW VSP with I/O Controller

- Install HW VSP (“**HW_VirtualSerialPort**” directory on our CD). When installing, make sure to check the option to install the second part. After installation, restart your PC.
- Make sure that NVT is enabled at the **UDP Setup** tab in the **Hercules** utility. If not, enable NVT and save the settings.
- Start HW VSP and find the devices at the “**UDPsetup**” tab. Select the MAC address of the device and click “**Use this IP**”. Change to the “**Virtual SP**” tab. The IP and Port should be already set. This search via UDP Broadcast works only on a local network.
- Select a serial port to create from the COM1 to COM20 range and click “**Create COM**”. The “LAN status” pane shows whether the device has been found. If so, the virtual serial port is created.
- As soon as you start any application that opens the selected virtual serial port (COM5 in this example), the HW VSP driver establishes a connection with the I/O Controller, configures the remote port (speed, parity, number of bits, handshake) to match the virtual serial port being opened, and starts transferring data.

Some applications have problems with serial port numbers higher than COM4. You can always use Hyperterminal in Windows, the Serial tab in the Hercules setup utility, or the “Terminal.exe” utility originating from Slovenia and available on the CD in the utils directory.

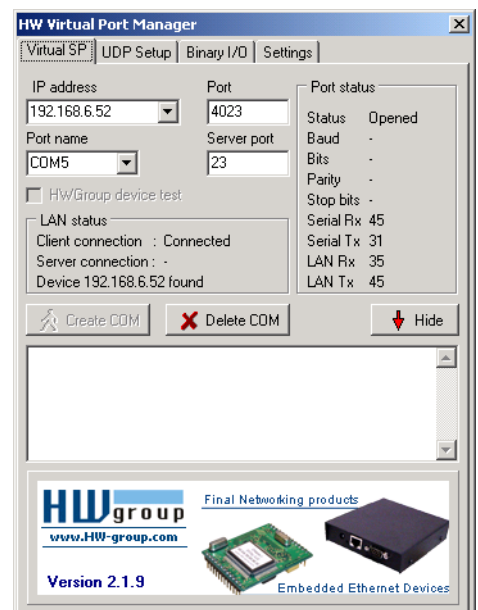

- Select the I/O Controller sub-tab in the “Binary I/O” tab. Here you can set and read digital inputs and outputs without additional software.

HW VSP settings

TEA Key pane

You can use TEA authentication to secure TCP/IP access. The same TEA key must be set and enabled at both sides of the communication.

NVT pane

Enables RFC2217 and detection of our remote ports. Remember to activate NVT support on the remote device as well.

- **NVT filter** – Filters out NVT control characters from the data flow.
- **NVT port setup** – Configures the remote port parameters via control commands to match the VSP in your PC. For example, if your terminal program (e.g. Hyperterminal) changes the baudrate to 19200 Bd and this box is checked, the VSP driver sends a NVT command (according to the RFC 2217 standard) to change the baudrate of the remote TCP/IP serial port.
- **Keep Connection** – Keeps the TCP/IP connection open even after 50 seconds of inactivity.

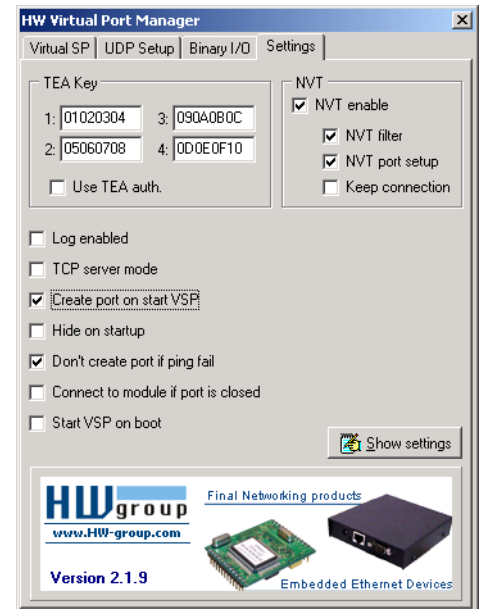

Main HW VSP parameters

- **Log enabled**
The VSP driver logs the virtual serial port activity to “C:\serialport.log”.
- **TCP server mode**
Activates VSP as a TCP/IP server. The driver then behaves as a TCP Client/Server device – the first side to receive any data switches to Client mode and establishes the connection.

The incoming TCP server port is configured at the main “Virtual SP” tab. We recommend using port numbers higher than 1025.
- **Create port on start VSP**
Automatically creates virtual ports when the driver is started. To create virtual ports at Windows startup, the “Start VSP on boot” box must be checked, too.
- **Hide on startup**
Hides VSP to to the system tray. The VSP icon is accessible near the clock.
- **Don't create port if ping fail**
Before creating the virtual serial port, tests if the device IP address responds.
- **Connect to module if port is closed**
If the virtual serial port is not in use by any application, checking this box can lead to losing some received data from the remote device.
- **Start VSP on boot**
Inserts the VSP path to the RUN key (HKEY_LOCAL_MACHINE\SOFTWARE\Microsoft\Windows\CurrentVersion\run) in the Windows registry. VSP is then started every time Windows starts.

HW VSP – command line parameters

HW VSP can be started with specific parameters on the command line. In this way, it is possible to create several virtual serial ports simultaneously on one computer. Detailed description of the parameters can be found at our website: www.HW-group.com.

Example: `CharonVirtualCom.exe -R -i192.168.6.21:23 -c5 -S0 -N1 -Nf -Np -H1`

I/O Controller configuration – Command description

The description of the settings combines WWW-based configuration and TCP/serial setup. Some functions are only available in serial/TCP setup (TEA security settings, QUIT mode).

I/O Controller status page

Shows an overview of the basic device parameters.

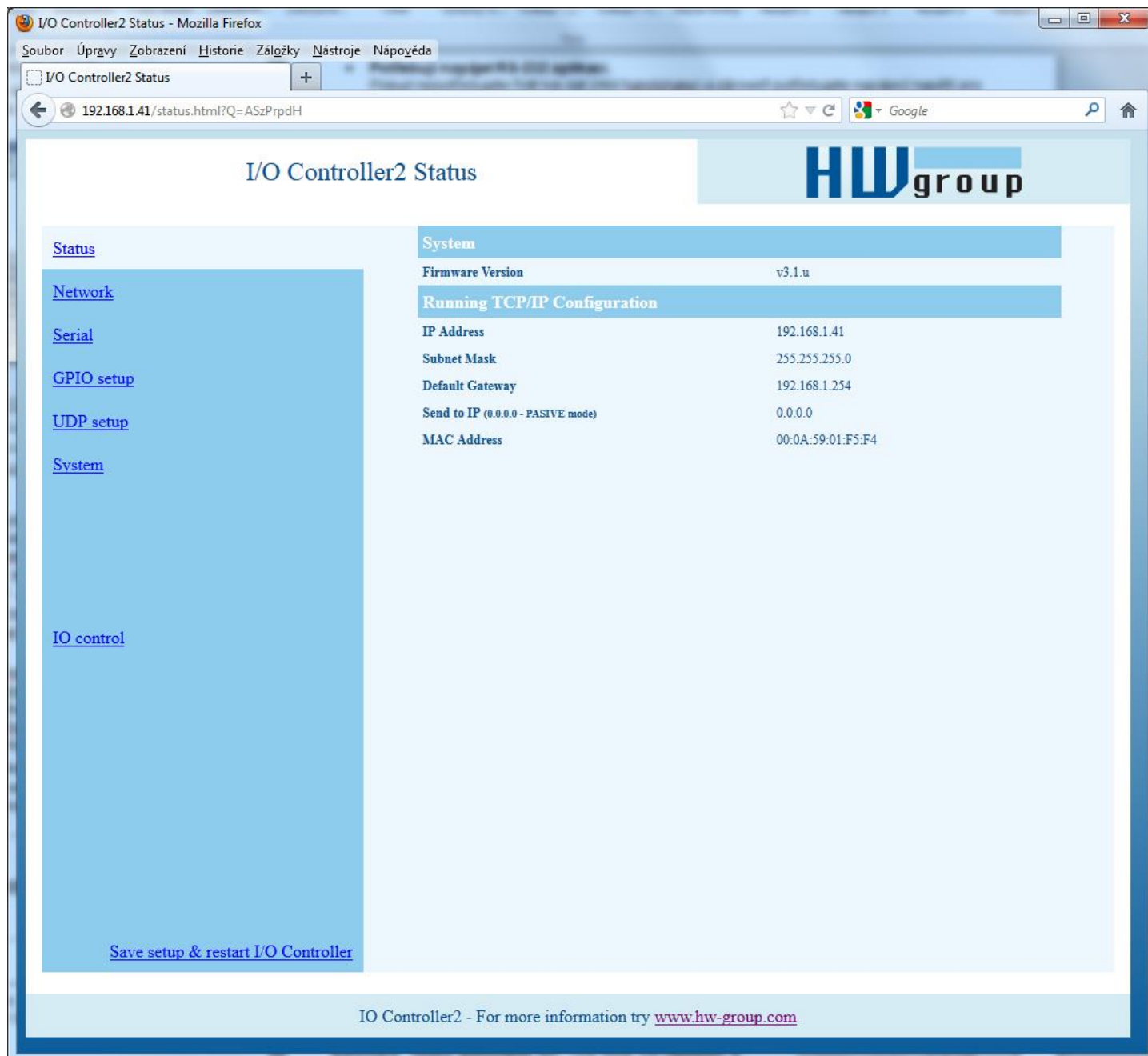

The screenshot shows a web browser window titled "I/O Controller2 Status - Mozilla Firefox". The address bar shows the URL "192.168.1.41/status.html?Q=ASzPrpdH". The page content includes a navigation menu on the left with links for Status, Network, Serial, GPIO setup, UDP setup, System, and IO control. The main content area is divided into two sections: "System" and "Running TCP/IP Configuration".

| System | |
|------------------|--------|
| Firmware Version | v3.1.u |

| Running TCP/IP Configuration | |
|------------------------------------|-------------------|
| IP Address | 192.168.1.41 |
| Subnet Mask | 255.255.255.0 |
| Default Gateway | 192.168.1.254 |
| Send to IP (0.0.0.0 - PASIVE mode) | 0.0.0.0 |
| MAC Address | 00:0A:59:01:F5:F4 |

At the bottom of the page, there is a link "Save setup & restart I/O Controller" and a footer that reads "IO Controller2 - For more information try www.hw-group.com".

Network parameters + TCP Setup Mode

I/O Controller2 Network Setup

HW group

[Status](#)

[Network](#)

[TCP mode setup](#)

[\(UDP mode setup\)](#)

[Serial](#)

[GPIO setup](#)

[MODBUS setup](#)

[System](#)

[IO Control](#)

[Save setup & restart I/O Controller2](#)

IP Setup

I: Address

M: Mask

G: Gateway

In IP access filter

W: Address

N: Mask

X: Port

Y: Port Mask

Channel 0

T: IP mode

J: Port

Active (Client/Server) mode

S: Send to IP (0.0.0.0 - PASIVE mode)

U: Port

I/O Controller2 - For more information try www.hw-group.com

I/O Controller2 TCP Mode Setup

Logo HW-group

[Status](#)

[Network](#)

[TCP mode setup](#)

[\(UDP mode setup\)](#)

[Serial](#)

[GPIO setup](#)

[MODBUS setup](#)

[System](#)

[IO Control](#)

[Save setup & restart I/O Controller2](#)

TCP Mode Setup

P: IP Active Call Timer (65535 - Off)

B: IP Protocol Retry

V: NetworkVirtualTerminal

K: Keep connection

E: Erase buffer on

I/O Controller2 - For more information try www.hw-group.com

MAC Address 00:0A:59:00:95:6C

MAC address is a unique device address in the Ethernet network and it is always factory-preset. You can find it on the label inside the device. Using this address, individual devices can be distinguished for example in the UDP section of the setup program.

The address respects restoring of the default configuration with the “D0” command.

I: Address 192.168.6.15

Configures the IP address of the converter.

J: Port 23

Configures the converter's communication port – from 1 to 65535.

Port 99 is reserved for TCP Setup, if supported by the particular model and enabled in the setup.

M: Mask 255.255.255.0

IP network mask applicable in the local network. Communication with all devices outside of the local network (as determined by the IP address and network mask) is directed through the gateway.

G: Gateway 192.168.6.254

Address of the Gateway that enables access to external networks (outside of the IP range defined by the converter's IP address and the mask).

===== In IP Setup =====**W: Address 0.0.0.0**

IP address of a network or a computer that is allowed to communicate with the device. This value must be the result of a bitwise AND of the remote IP address and the restriction mask (option N), otherwise the device does not react.

N: Mask 0.0.0.0

This mask restricts addresses that are allowed to communicate with the device. Security can be enhanced by setting a fixed address or a suitable restrictive mask that disallows communication with unauthorized parties.

X: Port 0.0**Y: Port Mask 0.0**

Restricts the range of TCP ports that can communicate with the device.

MASK, IP address and Gateway functions:

An Ethernet device communicates:

- **Within a local Ethernet network**
No Gateway used or needed. However, IP addresses of both sides must be within the configured mask. For example, a mask of 255.255.255.0 means that the IP addresses can only differ in the last byte.
- **Outside of the local network – through the Gateway**, which itself must have an IP address within the range delimited by the mask.

In addition to this basic configuration, it is possible to restrict the range of IP addresses allowed to communicate with the converter in “**In IP Setup**”. For debugging, we therefore recommend to keep this parameter set to 0.0.0.0.

$$(\text{IP attempting to access AND N}) = \text{W}$$

Access is granted if the above condition is true. AND represents bitwise multiplication.

===== Out IP Setup =====

S: Send to IP **192.168.0.252**

U: Port **23**

If the address in the S option is different from 0.0.0.0, the I/O Controller works as a Client/Server in the TCP mode. This means that if **no TCP/IP connection is established** and the device either receives serial port data (even a single byte) or the state of its digital inputs changes (in the range allowed by the #T option), the device periodically tries to initiate a TCP connection as a **TCP Client**. The device remains in the **TCP Server** mode in between attempts.

In the UDP mode, the I/O controller sends data from the serial port to this address/port. Control of digital inputs and outputs in the UDP mode is governed by #E and subsequent parameters.

Set S = 0.0.0.0 to switch the converter to the **TCP Server** mode.

B: IP Protocol Retry **124**

Determines the TCP connection timeout if no communication takes place. Predefined values are available through the asterisk notation:

- *1: 30 s (n = 35)
- *2: 1 min. (n = 45)
- *3: 2 min. (n = 63)
- *4: 5 min. (n = 77)
- *5: 10 min. (n = 101)
- *6: 15 min. (n = 124)
- *7: 30 min. (n = 144)
- *8: 1 h (n = 179)
- *9: 2 h (n = 249)

The timeout can be fine-tuned by specifying a value from 10 to 255 according to this formula:

- n < 16 .. n * 0.2 s
- n < 32 .. (n - 15) * 0.8 s + 3.0 s
- n < 64 .. (n - 31) * 3.2 s + 15.8 s
- n < 128 .. (n - 63) * 12.8 s + 118.2 s
- n < 256 .. (n - 127) * 51.2 s + 937.4 s

Example: B42 => (42-31)*3.2+15.8 = 51s

P: IP Active Call Timer (65535 – Off)

Port configuration in UDP mode

When UDP communication is used, the remote address must be specified here.

Otherwise, the communication will be unidirectional. Data from the I/O Controller are sent only to the specified address.

Setting the connection length

Keeping a TCP socket open is useful when small volumes of data need to be transferred as soon as they come in but HW VSP is not used or a permanent connection needs to be avoided. For the duration specified by the B option, the connection is kept open and data are sent immediately, without the delay for establishing a TCP connection.

On the other hand, a long timeout means a long period of inaccessibility through other sockets (disconnected cable, TCP setup).

T: IP mode **TCP**

Switches between the TCP and UDP protocols. UDP communication is faster but prone to lost packets or out-of-order delivery; therefore, it is only suitable for communication on a local network segment in a request-response mode, usually to convert RS485 communication.

The “**broadcast Rcv**” parameter allows receiving broadcasts.

UDP/IP mode does NOT support

- **NVT** commands
- **TEA** authentication

Challenge-response protocols can respond up to 40% faster.

0: TCP

1: UDP with broadcast Rcv Off

2: UDP with broadcast Rcv On

V: NetworkVirtualTerminal **Off**

Network Virtual Terminal enables interpretation of Telnet sequences, including certain RFC2217 extensions that enable on-the-fly changes of serial port parameters (speed, parity, etc.). NVT description can be found at our website: >> [“Support & download”](#) >> [“**NVT \(Network Virtual Terminal\) protocol description**”](#).

When communicating with the serial port using telnet, e.g. with the TeraTerm program or the Hercules utility, NVT should be enabled. If you don't want to use this option, set your client to “RAW” communication mode.

0: Off (do not use telnet control codes, pass through to serial port)

1: On (accept telnet control codes)

Note: *With NVT off, it is not possible to control the digital inputs and outputs, and the SETUP does not even show the corresponding settings.*

K: Keep connection **Off**

Keeps TCP connections alive to avoid automatic termination upon timeout specified by the **B: IP protocol retry time** parameter. When enabled, the device sends a NVT NOP command approximately every 5 seconds to check the connection state. If port sampling is enabled with the #T: Trigger AND mask parameter, the device sends an I/O keep command (FF FA 2C 37 ..) instead of a NOP (see #K, #L, #M, #N). NVT must be enabled for this parameter to take effect – when NVT is off, I/O Controller repeats the last packet sent and the Keep function is dependent on the remote TCP implementation.

0: no keep connection (preferred)

1: keep connection

E: Erase buffer on **Open connection**

Clears the internal device buffer when a connection is established or closed. This option is useful for instance when your remote peripheral periodically sends some kind of “I'm alive” characters, you only need to access it once in a while, and receiving all these characters from the buffer wastes time.

0: none

1: Close TCP/IP connection

2: Open TCP/IP connection

3: Open & Close TCP/IP connection

Serial port parameters

The screenshot shows the 'I/O Controller2 Serial Setup' web interface. The browser address bar shows '192.168.1.41/serial.html?Q=ASrUbV9J'. The page has a navigation menu on the left with links for Status, Network, Serial, GPIO setup, UDP setup, System, and IO Control. The main content area is titled 'Serial Setup' and contains the following parameters:

| Parameter | Value |
|---|------------------------------|
| &B: Speed | 9600 |
| &D: Data bits | 8 |
| &P: Parity | None |
| &V: Variable Parity | Off |
| - &M: Multidrop mask (0 = DISABLE Multidrop) | 255 |
| - &N: Multidrop network address | 65 |
| &S: Stop bits | 1 |
| &C: Flow Control | None |
| &R: RTS Output | continuously asserted [~+8V] |
| &A: DTR Output | unasserted [~-8V] |
| &T: Serial Line Timeout (0 - Off) | 0 |
| &G: Char. Transmit Delay (0 - Off) | 0 |
| &H: Tx Control | Tx FULL duplex |
| &I: RS232/RS485/RS422 mode | RS232 |
| %S: TCP/IP setup | On |

At the bottom of the page, there is a 'Send' button and a footer that reads 'IO Controller2 - For more information try www.hw-group.com'.

===== Serial Setup =====

&B: Speed **9600**

Sets the communication speed for the serial line. Any speed from 50 to 115,200 Bd can be set. To set 9600 Bd, enter “&B9600”. The resolution depends on the speed. Up to about 1000 Bd, 1 Bd steps can be used. At 10 kBd, only 100 Bd steps are still usable.

&D: Data bits **8**

Number of data bits in the serial communication.

7: 7 bits / 8: 8 bits – for instance, to set 8 data bits, enter “&D8”.

&P: Parity **NONE**

Parity of the serial asynchronous communication.

For example, to configure communication without parity, enter "&PN".

N: none / O: odd / E: even / M: mark / S: space

&V: Variable Parity Parity **Off**

Supplemental function for 9-bit protocols. Only the difference from the pre-set parity bit value is transmitted. For correct operation, a parity needs to be set (usually Mark/Space). A double character (0xFE followed by "P") is used to transfer the difference from the pre-set parity. In this mode, the 0xFE character is a prefix; if it appears within the data stream, it needs to be doubled. This option is recommended for the box-2-box mode (two converters connected back-to-back) and 9-bit protocols.

Off: incorrect parity bit ignored

On: incorrect parity bit transmitted to the other device

For instance, to set up 9-bit communication with a majority of data having "space parity", enter: "&PS;&V1" (space parity + variable parity on).

&S: Stop bits **2**

Number of stop bits for the serial communication. As a rule, there should be at least 9 bits and at most 10 bits in total, excluding the start bit. For instance, the 7N1 setting (7+0+1 bits) is corrected by the setup to 7N2. Similarly, 8E2 (8+1+2 bits) is corrected to 8E1.

&C: Flow Control **NONE**

Serial data flow control. If you use data flow control and the input buffer is full, handshake will signal over the serial port that the I/O Controller can no longer accept data.

- 1: none** – No control, for RTS function see &R
- 2: RTS/CTS** – RTS/CTS control pins
- 3: Xon/Xoff** – Software flow control
- 4: Xon/Xoff HeartBeat** – SW flow control with periodic Xon transmission (heartbeat)

&R: RTS Output Continuously asserted [~ +8V]

Defines the idle level of the RTS output pin. Important for devices powered from the RTS pin.

- 0: RTS = continuously asserted [~ +8V]**
- 1: RTS = unasserted [~ -8V]**
- 2: RTS = asserted while connected**

&A: DTR Output

Defines the idle level of the DTR output pin. Important for devices powered from the DTR pin.

- 0: DTR = continuously asserted [~ +8V]**
- 1: DTR = unasserted [~ -8V]**
- 2: DTR = asserted while connected**

&I: RS485/RS422 control Off

For RTS or downstream RS485 converters that use RTS to toggle transmission/reception. For the built-in RS-485 driver, the “**HW echo**” option applies, meaning that the device reads back the data sent to the RS-485 line and generates an echo from the actual RS-485 bus.

0: Off

2: TxRTS HW echo ON (recommended for **RS-485 debug only!**)

3: TxRTS HW echo OFF (**RS-485**)

Note: For most RS-485 applications, set &R3TxRTS HW echo OFF.

&T: Serial Line Timeout 0 – Off

If no data are received from the serial line for the specified time, characters received so far are packed into an Ethernet packet and sent off.

The timeout is specified as the **number of characters**, and displayed as the number of chars as well as the time based on the current serial communication speed. If the speed changes, the time is recalculated but the number of characters defining the timeout stays the same (10 characters means about 11 ms at 9600 Bd, or 5.7 ms at 19200 Bd).

&G: Char. Transmit Delay 0 – Off

When controlling devices with a small RS232 buffer, it is sometimes advantageous to keep a relatively high baud rate but insert delays between individual characters. The delay is specified in **milliseconds** and defines the time between the starts of individual characters. Therefore, delays under 2 ms have no effect at 2400 Bd because individual characters are 2.4 ms apart.

&H: Tx Control Tx FULL duplex

When HALF duplex is activated, the converter expects unidirectional communication over the serial line (RS485) and never starts to transmit data while receiving.

0: FULL duplex (RS-232)

1: HALF duplex (RS-485)

&Q: EOT Trigger character 26

Packet termination character. The default is 26 (ctrl-Z in ASCII). In common operating systems, ctrlZ is the EOF (End Of File) character. When this character is received from the serial line, the device does not wait for the “&T” timeout and immediately sends everything as a packet over LAN.

%S: TCP/IP setup On

Enables or disables remote configuration through the TCP Setup at port 99. This command only works in the **RS-232 Setup** mode.

0: TCP Setup disabled

1: TCP Setup enabled (TCP server at port 99)

Configuring the control of inputs and outputs

TCP/IP mode needs to be configured and NVT (Network virtual terminal) enabled in order to work with the digital inputs and outputs. Otherwise, the commands are not even displayed.

Digital inputs and outputs are controlled over the **Network Virtual Terminal**. This means that the I/O control commands are embedded into the TCP/IP data stream, along the serial port data. However, these commands only appear in the Ethernet communication, they never pass through to the serial port.

In recent firmware versions, digital inputs and outputs can be controlled from the serial port or over an UDP connection (see #E and #V).

NVT commands are always prefixed with a control character and have a predefined binary format. A detailed description of the NVT protocol with examples of commands is available at our website (in the “Support & Download” section).

Note: Remember to set the desired initial value of outputs after reset.

The screenshot displays the 'I/O Controller2 GPIO Setup' web interface. The browser address bar shows '192.168.100.72/gpio.shtml?Q=ASnR2Wef'. The page features a sidebar with navigation links: Status, Network, TCP mode setup, (UDP mode setup), Serial, GPIO setup, MODBUS setup, System, and IO Control. The main content area is divided into several sections:

- I/O Power Up:**
 - #A: Power Up INIT: 0
 - #B: Power Up AND mask: 255
 - #C: Power Up OR mask: 0
 - #D: Power Up XOR mask: 0
- GPIO Mask:**

| GPIO Mask | NVT I/O | NVT keep I/O |
|-----------------|---------|--------------|
| #X#K: KEEP mask | 0 | 255 |
| #Y#L: AND mask | 255 | 0 |
| #Z#M: OR mask | 0 | 0 |
| #W#N: XOR mask | 0 | 0 |
- I/O TCP/IP Connection:**

| I/O TCP/IP Connection | Open | Close |
|-----------------------|------|-------|
| #1/#4: AND mask | 255 | 255 |
| #2/#5: OR mask | 0 | 0 |
| #3/#6: XOR mask | 0 | 0 |
- I/O trigger and edge mask:**
 - #T: Trigger AND mask: 255
 - #R#F: Rise/Fall edge mask: 0
- UDP I/O control:**
 - #E: GPIO control from UDP: Off
 - #J: Port: 24
- Active UDP mode:**
 - #S: Send to IP: 0.0.0.0
 - #U: Port: 24
- COM I/O control:**
 - #V: GPIO control from COM: Off

A 'Send' button is located at the bottom right of the configuration area. At the bottom of the page, there is a footer: 'I/O Controller2 - For more information try www.hw-group.com'.

===== I/O Control Setup =====

#T: Trigger AND mask 240

Defines inputs whose **changes are automatically transmitted to the remote side** (IP address S=X.X.X.X and port U) and synchronized with its outputs, if they change.

Only those inputs for which the corresponding bits of #T are set to 1 are transmitted.

Examples:

- **#T = 0 (0x00)** – I/O Controller does not react to any changes at digital inputs I0 through I8.
- **#T = 240 (0xF0)** – I/O Controller only reacts to changes at digital inputs I7, I6, I5, I4. Changes at inputs I3 to I0 are ignored. However, their changed values are always transmitted together with any reaction to a change at I7..I4.
- **#T = 255 (0xFF)** – I/O Controller reacts to any change at any digital input I0 through I8.

Transmission means that whenever the I/O Controller is in the Client/Server mode (“Active mode”), it reacts to changes at its inputs just as it reacts to incoming data from the serial port = if the connection is closed, the I/O Controller establishes a connection with the specified remote side and sends the appropriate NVT command to set the remote outputs.

If the TCP Server mode (“Passive mode”) is used and the connection is closed, nothing happens. If the connection is open, data are sent through the open connection.

Note: *Even if the input states are not transmitted to the remote side, they can still be read using the standard NVT commands for reading inputs.*

I/O Controller distinguishes three **types of synchronization** when using two devices back-to-back. Their parameters are usually configured in a similar way:

- **Power Up init – (#B, #C, #D parameters)** – After reset, I/O Controller sets the output to the value specified in #A and attempts to contact the remote IP defined with S=x.x.x.x. When successful, it requests the state of the remote device's inputs and sets its own inputs according to the following formula.

$$\text{OUTPUT} = ((\text{retrieved remote data AND } \#B) \text{ OR } \#C) \text{ XOR } \#D$$

- **Data change – (#X, #Y, #Z, #W parameters)** – Upon every change at the inputs (as restricted with #T), I/O Controller informs the remote device. The remote device receives the value and uses the second formula to set its outputs.
- **Keep I/O – (#K, #L, #M, #N parameters)** – I/O Controller periodically sends the state of its inputs to the remote side.

Data synchronization after RESET (Power Up init):

The device keeps trying to establish the connection for approximately 120 seconds after powering up. If it does not succeed, the **#A: Power Up INIT** value remains at the output.

#A: Power Up INIT 0

A decimal value from **0 to 255** that is written to the **output register** after **device reset** (or power failure), before the I/O Controller attempts to establish a connection with the remote unit and synchronize their digital inputs and outputs.

#B: Power Up AND mask 255

Binary mask of values from the remote side that affect the outputs when initializing for the first time (after reset or power up).

#C: Power Up OR mask 0

Range of digital output values that can be influenced by the states of inputs retrieved from the remote side after RESET.

Bitwise OR

| | | |
|------------|-------------|--------------|
| 0 (0x00) | OR 0 (0x00) | = 0 (0x00) |
| 255 (0xFF) | OR 0 (0x00) | = 255 (0xFF) |
| 255 (0x0F) | OR 3 (0x03) | = 255 (0xFF) |
| 240 (0xF0) | OR 8 (0x08) | = 248 (0xF8) |

#D: Power Up XOR mask 0

The binary XOR function is suitable inverting individual output bits. This is used, for example, when a button closes against GND but the corresponding relay needs to switch against +PWR (logic LOW at the input needs to be inverted to logic HIGH at the output).

Examples:

- **#D = 0 (0x00)** – Values are transferred without changes. Logic HIGH at an input results in a logic HIGH at the respective output.
- **#D = 1 (0x01)** – The D0 output bit is inverted with respect to the D0 input bit. Values at D1 through D7 are transferred without changes. Logic HIGH at an input results in a logic HIGH at the respective output.
- **#D = 255 (0xFF)** – All output bits are inverted with respect to the respective input bits.

Data synchronization in normal operation:

$$\text{OUTPUT} = ((\text{PrevOut AND } \#X) \text{ OR } (\text{RxData AND } \#Y) \text{ OR } \#Z) \text{ XOR } \#W$$

- **PrevOut** = previous output state
- **RxData** = received remote data

Note: *The previous formula is only used when two I/O Controllers are connected to each other back-to-back. Inputs at one device are automatically mirrored at the outputs of the other device. This is called the **Box-2-Box** mode. Standard NVT commands can be used to access all the 8 output bits either directly, without respect to the #B to #Z parameters, or using the defined masks.*

However, in the common Box-2-Box mode, it is not possible to access the output states from a PC because the I/O Controller supports only one TCP connection at a time. As long as a TCP connection to the other I/O Controller is established, the I/O Controller cannot be accessed from a PC.

#X: KEEP mask 0

Defines the outputs that will keep their previous values (using bitwise AND).

#Y: AND mask 255

Using bitwise AND, defines the inputs whose states are transmitted from the remote side to the outputs of the I/O Controller.

Bitwise AND

| | | |
|------------|---------------|------------|
| 0 (0x00) | AND 0 (0x00) | = 0 (0x00) |
| 255 (0xFF) | AND 0 (0x00) | = 0 (0x00) |
| 255 (0x0F) | AND 3 (0x03) | = 3 (0x03) |
| 240 (0xF0) | AND 16 (0x0F) | = 0 (0x00) |

Note: *Be careful when controlling the outputs over NVT and using the Box-2-Box mode at the same time. #X and #Y can define which bits can be set only over NVT and which bits will be synchronized with the remote inputs.*

Example: #Y= 0x00, #X=0xFF – The output is not affected by the remote side at all, all output bits can be controlled over NVT.

#Z: OR mask 0

Defines the output bits that will be affected by automatic synchronization – see #C.

#W: XOR mask 0

The bitwise XOR function is useful for inverting individual output bits with respect to the respective remote inputs – see #D.

Bitwise XOR

| | | |
|------------|----------------|--------------|
| 0 (0x00) | XOR 0 (0x00) | = 0 (0x00) |
| 255 (0xFF) | XOR 0 (0x00) | = 255 (0x00) |
| 255 (0x0F) | XOR 3 (0x03) | = 252 (0xFC) |
| 0 (0x00) | XOR 255 (0xFF) | = 255 (0xFF) |

Periodic data synchronization in normal operation:

$$\text{Output} = ((\text{PrevOut AND } \#K) \text{ OR } (\text{RxData AND } \#L) \text{ OR } \#M) \text{ XOR } \#N$$

- **PrevOut** = previous output state
- **RxData** = received remote data

Keep I/O – (#K, #L, #M, #N parameters) – I/O Controller periodically sends the states of its inputs to the remote side.

| | | |
|------------|------------------|-----|
| #K: | KEEP mask | 255 |
| #L: | AND mask | 0 |
| #M: | OR mask | 0 |
| #N: | XOR mask | 0 |

#K#L#M#N commands correspond to #X#Y#Z#W and define the behavior when two I/O Controllers are connected back-to-back and configured to periodically transmit port states. #X#Y#Z#W commands define the behavior of the two I/O Controllers whenever the port states change (more precisely, whenever the bits determined by #T change).

#H: I/O HeartBeat Off

Configures I/O Controller behavior when periodically transmitting input states. It is related to the **K: Keep connection** parameter.

- **K0** disables periodic state transmission, #K#L#M#N#H have no effect and are inaccessible in the menu.
- **K1;H0** enables periodic state transmission only when nothing else is sent (e.g. data from the serial port).
- **K1;H1** enables periodic state transmission approximately every 5 seconds regardless of the serial port communication.

Setup examples

Using the described parameters, each bit can be independently configured either to keep a fixed value, to synchronize itself with changes at an input, or to invert its state with respect to the state of an input. Study the following examples:

Output = (X.n =0 Y.n =0 Z.n =0) – output at logic LOW, configurable only with NVT commands

Output = (Z.n =1) – output at logic HIGH, configurable only with NVT commands

Output = (X.n=0 Y.n=1 Z.n=0 W.n=0) – output is an exact copy of the remote input

Output = (X.n=0 Y.n=1 Z.n=0 W.n=1) – output is an inverted copy of the remote input

Note: *In normal operation, the inputs are sampled every millisecond and a change is registered whenever the input value differs from the last transmitted value in two consecutive samples (= the change lasts at least 1.2 to 2.0 ms).*

I/O TCP/IP Connection

Umožní nastavit výstupy při ztrátě či obnovení TCP spojení do požadovaného stavu

- #1 AND mask for Opened TCP Connection
- #2 OR mask for Opened TCP Connection
- #3 XOR mask for Opened TCP Connection
- #4 AND mask for Closed TCP Connection
- #5 OR mask for Closed TCP Connection
- #6 XOR mask for Closed TCP Connection

Masky se počítají identicky jako v případě parametrů GPIO Mask, tedy:

#Y/#L: AND mask

#Z/#M: OR mask

#W/#N: XOR mask

Transmitting input states upon an edge

I/O Controllers can transmit current input states to corresponding outputs at a specified remote device. The inputs to mirror are defined by the edge mask.

----- I/O edge mask -----

#R: Rise edge mask 255

Defines the inputs that will be monitored for **rising edges**. A rising edge triggers the transmission of information about an input state change (“closed” state is transferred):

255=all inputs, 00=no inputs.

#F: Fall edge mask 255

Defines the inputs that will be monitored for **falling edges**. A falling edge triggers the transmission of information about an input state change (“open” state is transferred):

255=all inputs, 00=no inputs.

Configuration of I/O control

I/O lines can be controlled over:

- **WEB**
- **TCP Telnet** (NVT commands)
- **RS-232** (NVT commands sent to the serial port – #V)
- **UDP** (NVT commands via UDP to the specified port – #U)
- **Modbus/TCP**

----- I/O control -----

#E: GPIO control from UDP Off

#J: Port 24

When enabled, commands to change output states can be sent to the I/O Controller over UDP as well as over TCP.

#J defines the UDP port where the I/O commands need to be sent.

#S: Send to IP 192.168.0.252

#U: Port 4024

When the UDP GPIO Control mode is enabled, I/O Controller sends the state changes to the specified address and port.

#V: GPIO control from COM Off

When enabled, I/O Controller inputs and outputs can be controlled over the serial line. Commands are similar to NVT commands – 0xFE prefix followed by a NVT command. For example, 0xFE 0x33 xx sets the output to xx. The prefix is the same as for the &V command.

System

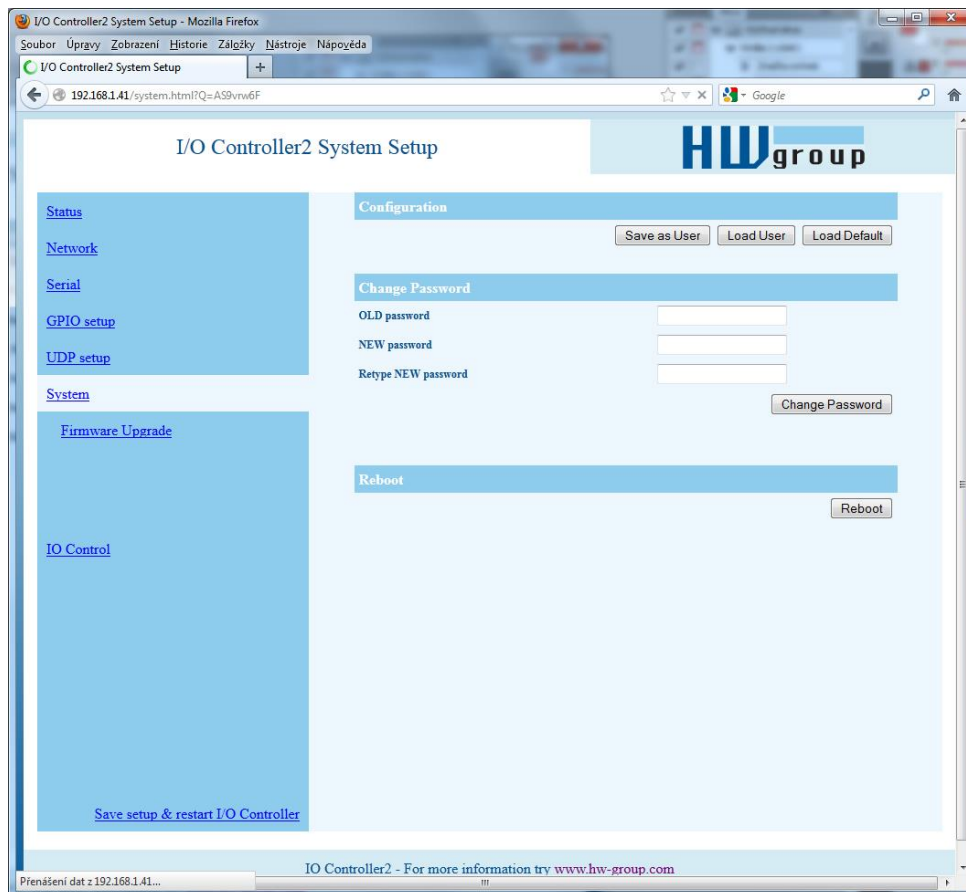

===== Other =====

D: Load/Save Settings from/to Flash

Saves the current settings to memory, or restores saved settings.

- 0:** Restores settings from **slot 1**
- 1:** Restores settings from **slot 2**
- 2:** Stores current settings to **slot 1**
- 3:** Stores current settings to **slot 2**

R: Reboot

Software restart. Necessary e.g. when the IP address is changed. Recommended after changing parameters in TCP Setup.

Change Password

Applies only to WWW access. The default password is 1234.

UDP/IP mode settings

When “**T: IP mode UDP**” is chosen, the device will communicate with the remote party using UDP packets. Also, the following menu appears in the Setup.

| Triggering Setup | |
|----------------------------|--|
| *L: Trigger Length(0..4) | <input type="text" value="1"/> |
| *P: Post Trigger Length | <input type="text" value="256"/> |
| *S: Start Trigger Pattern | <input type="text" value="58.0.0.0"/> |
| *M: Start Trigger Mask | <input type="text" value="255.0.0.0"/> |
| *X: Stop Trigger Pattern | <input type="text" value="10.0.0.0"/> |
| *Y: Stop Trigger Mask | <input type="text" value="255.0.0.0"/> |
| *E: Max. Start-Stop Length | <input type="text" value="999"/> |

[Save setup & restart I/O Controller](#)

IO Controller2 - For more information try www.hw-group.com

==== Triggerring Setup =====***L: Trigger Length 1**

Number of bytes for the packet start and packet end triggering condition. Allowed values are 0 to 4. If the lengths of your start and end conditions differ, use the trigger condition mask and remember to include the masked characters in the length of the triggering condition, even though they contain actual frame data.

***P: Post Trigger Length 0**

In some protocols, the packet end condition is followed e.g. by a checksum. This condition defines the number of characters that make up a packet after the packet termination condition. If the start and stop trigger conditions are equal, this value specifies the packet length without the leading 0 to 4 bytes of the start trigger.

***S: Start Trigger Pattern 58.0.0.0**

(4B input data AND *M) = *S

Start trigger condition for packet transmission. Four bytes are set; however, only the number of bytes specified in "L: Trigger Length" is considered.

***M: Start Trigger Mask 255.0.0.0**

Mask of the start trigger condition. Masking works similarly to the Ethernet netmasks using a bitwise AND. Value of 255 means that the tested character must be equal to the character specified in "V: Start Trigger Pattern". For example, to start the transfer with any ASCII control character (0..31d), use 0.0.0.0 for the trigger pattern, 224.0.0.0 for the mask and 1 for the length. If you set the character to 0 and the mask to 0, the trigger matches any character.

***X: Stop Trigger Pattern 10.0.0.0**

(4B input data AND *Y) = *X

Sets the stop trigger condition for sending data to the Ethernet.

***Y: Stop Trigger Mask 255.0.0.0**

Mask of the stop packet trigger condition for serial line data. For example, the settings displayed here are intended for transferring data in the IntelHEX format over RS485. The start trigger is a colon and the transfer is terminated after receiving the <LF> (0Ah = 10d) control character.

***E: Max. Start-Stop Length 999**

Maximum number of characters that the device sends after the START trigger, unless the STOP trigger is encountered sooner. After transmission, another START trigger is expected. Essentially, this is a "timeout" specified as the number of characters.

Configuration example

To send all data from the serial line to the remote device, use this configuration:

```
*L: Trigger Length      0
 *P: Post Trigger Length 0
 *S: Start Trigger Pattern 0.0.0.0
 *M: Start Trigger Mask  0.0.0.0
 *X: Stop Trigger Pattern 255.0.0.0
 *Y: Stop Trigger Mask   255.0.0.0
 *E: Max. Start-Stop Length 200
```

Parameters unavailable in the WWW interface

Security

==== Security Setup =====

%A: TCP autorisation **Off**

Activates TEA authentication (one-time exchange and password verification to allow the TCP connection to be established) – requested from the remote side after the connection is established.

0: TEA authentication Off

1: TEA authentication On

%K: TEA key 0:01:02:03:04 1:05:06:07:08 2:09:0A:0B:0C 3:0D:0E:0F:10

Use “%K” to set the TEA key. Set 16 bytes as four quadruples of colon-separated hex values. The first character identifies the quadruple (0th to 3rd). So, to set the last 4 bytes to the displayed value, use “%K3:0D:0E:0F:10”. The key is used to verify one-time passwords (OTP) when authenticating the remote side.

Other device parameters

Q: Quiet (Batch) mode

Quiet mode is useful when the configuration parameters need to be handled automatically, with a script. Quiet mode is enabled with “**Q1**”. After pressing Enter, the device responds with a list of parameters in the following format:

```
WEB51=2.L=00:0A:59:00:A6:08;I192.168.1.24;J23;M255.255.255.0;G192.168.1.1;W0.0.0.0;N0.0.0.0;X0.0;Y0.0;S192.168.6.51;U4023;T0;V0;K1;A250;&B9600;&D8;&P1;&S1;&C1;&R0;&T0;&G0;&H0;%A0;%K01:02:03:04:05:06:07:08:09:0A:0B:0C:0D:0E:0F:10;%S1;#T3;#A3;#B192;#C3;#D0;#X0;#Y0;#Z3;#W0;*L1;*P0;*S58.0.0.0;*M255.0.0.0;*X10.0.0.0;*Y255.0.0.0;*E999
```

What's new in the WEB interface

IO Control – Read inputs and control outputs

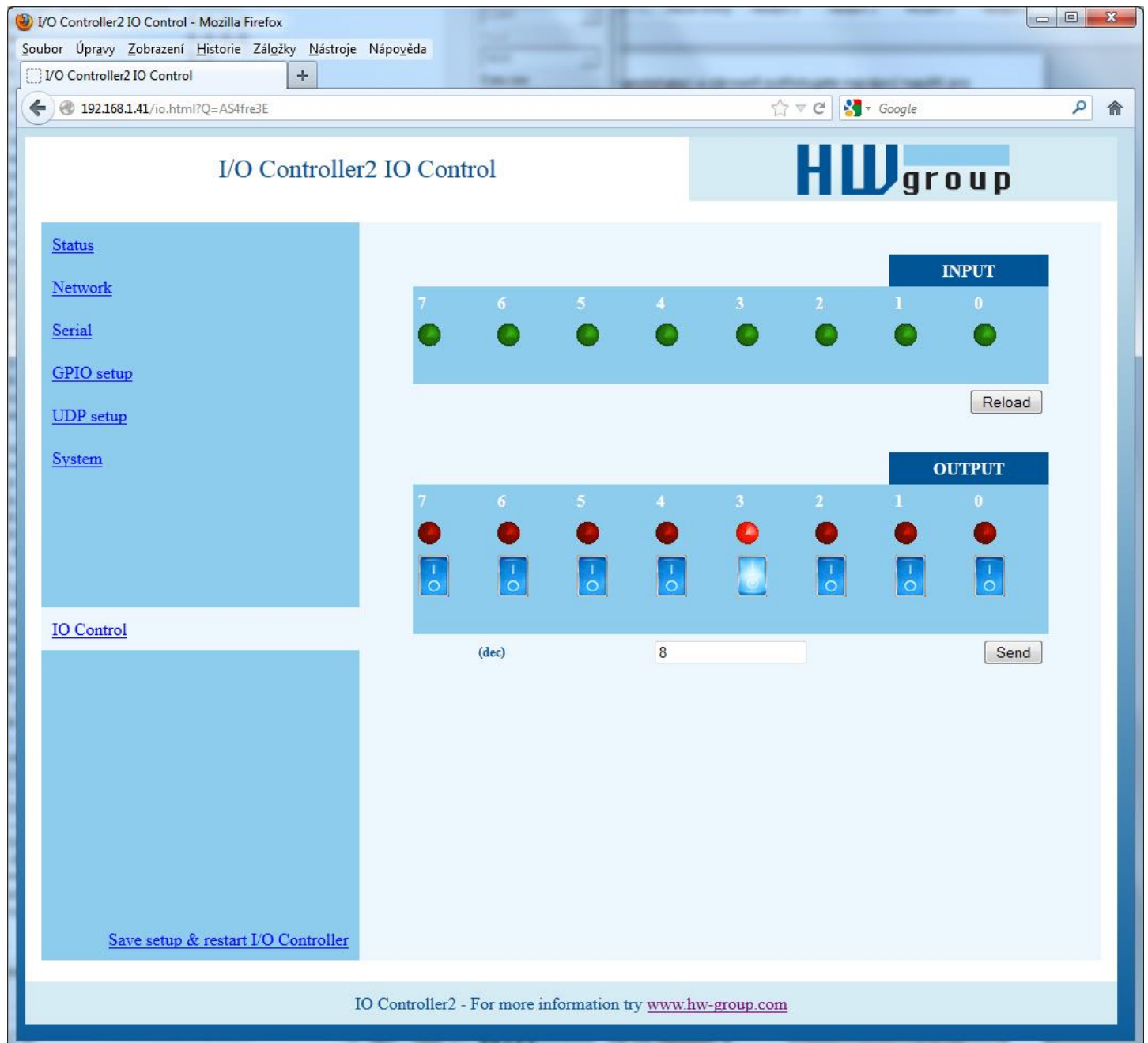

Outputs can be controlled either by entering a decimal value 0–255 corresponding to the output states, or by toggling the switches at the WWW page.

Firmware upgrade

Upgrades the current device firmware. This operation may change some settings.

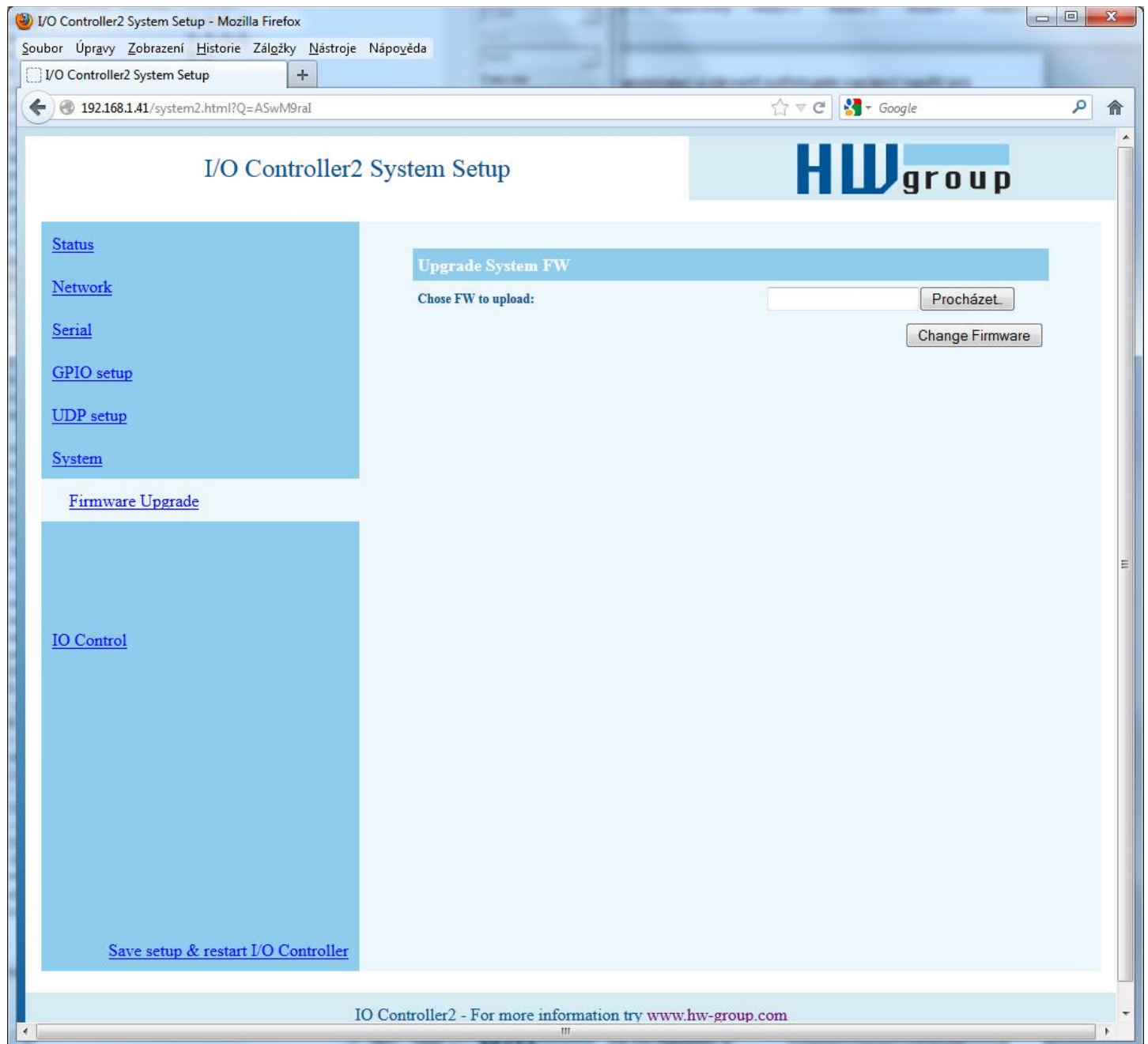

Default settings

```

*** HW-group.com HW 6.0 SW 3.1.u #01 ***
***      PortBox I/O      ***

MAC Address          00:0A:59:01:F5:F4
===== IP Setup =====
I: Address           192.168.1.41
J: Port              23
M: Mask              255.255.255.0
G: Gateway           192.168.1.254
===== In IP access filter =====
W: Address           0.0.0.0
N: Mask              0.0.0.0
X: Port              0.0
Y: Port Mask         0.0
== Active (Client/Server) mode ==
S: Send to IP        PASSIVE mode
U: Port              23
B: IP Protocol Retry 124
T: IP mode           TCP
V: NetworkVirtualTerminal On
K: Keep connection   Off
E: Erase buffer on   None
Press <Enter> to continue
===== Serial Setup =====
&B: Speed            9600
&D: Data bits        8
&P: Parity            None
&V: Variable Parity  Off
&S: Stop bits        1
&C: Flow Control     None
&R: RTS Output       continuously asserted [~ +8V]
&A: DTR Output       unasserted [~ -8V]
&T: Serial Line Timeout 0 - Off
&G: Char. Transmit Delay 0 - Off
&H: Tx Control       Tx FULL duplex
&I: RS485/RS422 control Off
===== Security Setup =====
%A: TCP autorisation Off
%K: TEA key 0:01:02:03:04 1:05:06:07:08 2:09:0A:0B:0C 3:0D:0E:0F:10
%S: TCP/IP setup     On
Press <Enter> to continue
===== I/O Control Setup =====
#T: Trigger AND mask 255
#A: Power Up INIT    0
#B: Power Up AND mask 255
#C: Power Up OR mask 0
#D: Power Up XOR mask 0
#X: KEEP mask        0
#Y: AND mask          255
#Z: OR mask           0
#W: XOR mask          0
----- I/O edge mask -----
#R: Rise edge mask   0
#F: Fall edge mask   0
----- I/O control -----
#E: GPIO control from UDP Off
----- Active COM mode -----
#V: GPIO control from COM Off
Press <Enter> to continue
===== Other =====
D: Load/Save Settings from/to Flash
R: Reboot
WEB51>

```

Practical configuration examples

The following examples show the configuration of essential parameters for typical applications.

2x I/O Controller connected to each other (Box-2-Box)

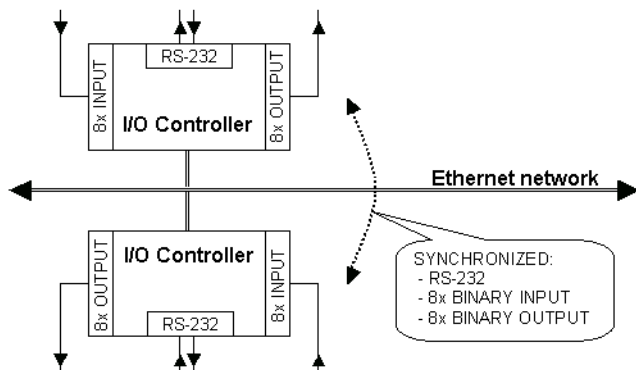

Virtual extension of the serial port + 8 inputs and 8 outputs over TCP/IP.

The serial port is set to 19,200 Bd, 8N1, SW handshake, states of digital inputs are mirrored at the corresponding outputs.

The TCP connection automatically closes after 50 seconds, and opens again upon a change at an input or upon receiving any data from the serial port.

I/O Controller 1

```

*** HW-group.com HW 4.7 SW 2.L #01 ***
*** I/O Controller ***

MAC Address 00:0A:59:00:00:00
===== IP Setup =====
I: Address 192.168.1.1
J: Port 4023
M: Mask 255.255.255.0
G: Gateway 192.168.1.254
===== In IP access filter =====
W: Address 0.0.0.0
N: Mask 0.0.0.0
X: Port 0.0
Y: Port Mask 0.0
== Active (Client/Server) mode ==
S: Send to IP 192.168.1.2
U: Port 4023
T: IP mode TCP
V: NetworkVirtualTerminal On
K: Keep connection Off
E: Erase buffer on None
===== Serial Setup =====
&B: Speed 19200
&D: Data bits 8
&P: Parity NONE
&V: Variable Parity Off
&S: Stop bits 1
&C: Flow Control Xon/Xoff
&R: RS485/RS422 control RTS = On [+8V]
&T: Serial Line Timeout 0 - Off
&G: Char. Transmit Delay 0 - Off
&H: Tx Control Tx FULL duplex
===== Security Setup =====
%A: TCP autorisation Off
%K: TEA key 0:01:02:03:04 1:05:06:07:08
2:09:0A:0B:0C 3:0D:0E:0F:10
%S: TCP/IP setup On
===== I/O Control Setup =====
#T: Trigger AND mask 255
#A: Power Up INIT 189
#B: Power Up AND mask 255
#C: Power Up OR mask 0
#D: Power Up XOR mask 0
#X: KEEP mask 0
#Y: AND mask 255
#Z: OR mask 0
#W: XOR mask 0
===== Other =====
D: Load/Save Settings from/to Flash
R: Reboot

WEB51>

```

I/O Controller 2

```

*** HW-group.com HW 4.7 SW 2.L #01 ***
*** I/O Controller ***

MAC Address 00:0A:59:00:00:00
===== IP Setup =====
I: Address 192.168.1.2
J: Port 4023
M: Mask 255.255.255.0
G: Gateway 192.168.1.254
===== In IP access filter =====
W: Address 0.0.0.0
N: Mask 0.0.0.0
X: Port 0.0
Y: Port Mask 0.0
== Active (Client/Server) mode ==
S: Send to IP 192.168.1.1
U: Port 4023
T: IP mode TCP
V: NetworkVirtualTerminal On
K: Keep connection Off
E: Erase buffer on None
===== Serial Setup =====
&B: Speed 19200
&D: Data bits 8
&P: Parity NONE
&V: Variable Parity Off
&S: Stop bits 1
&C: Flow Control Xon/Xoff
&R: RS485/RS422 control RTS = On [+8V]
&T: Serial Line Timeout 0 - Off
&G: Char. Transmit Delay 0 - Off
&H: Tx Control Tx FULL duplex
===== Security Setup =====
%A: TCP autorisation Off
%K: TEA key 0:01:02:03:04 1:05:06:07:08
2:09:0A:0B:0C 3:0D:0E:0F:10
%S: TCP/IP setup On
===== I/O Control Setup =====
#T: Trigger AND mask 255
#A: Power Up INIT 189
#B: Power Up AND mask 255
#C: Power Up OR mask 0
#D: Power Up XOR mask 0
#X: KEEP mask 0
#Y: AND mask 255
#Z: OR mask 0
#W: XOR mask 0
===== Other =====
D: Load/Save Settings from/to Flash
R: Reboot

WEB51>

```

- To permit communication with only one address, set N:255.255.255.255 and W:IP address of the remote device.
- To use 9-bit communication, enable &V1 = &V: Variable Parity On at both devices.
- To enhance security, disable TCP Setup at port 99 with %S0 = %S: TCP/IP setup Off at both devices.

If security is an essential requirement and the device should only communicate within the local network, use the following settings. In this case, only communication within the LAN segment is allowed (0 to 255 at the end of the IP address).

| | |
|--------------------------|---------------|
| I: Address | 192.168.1.1 |
| M: Mask | 255.255.255.0 |
| ==== In IP access filter | ===== |
| W: Address | 192.168.1.0 |
| N: Mask | 255.255.255.0 |
| S: Send to IP | 192.168.1.2 |

| | |
|--------------------------|---------------|
| I: Address | 192.168.1.2 |
| M: Mask | 255.255.255.0 |
| ==== In IP access filter | ===== |
| W: Address | 192.168.1.0 |
| N: Mask | 255.255.255.0 |
| S: Send to IP | 192.168.1.1 |

Controlling inputs and outputs via NVT

The following is a short overview of controlling the I/O Controller via the M2M NVT protocol. It is an extract from the detailed description of NVT that is available at our website:

http://www.hw-group.com/support/nvt/index_en.html

What is NVT and RFC2217

NVT is a method of embedding control commands into a binary data stream. NVT (Network Virtual Terminal) is also used by the Telnet protocol to transfer commands. In this way, Telnet transfers control sequences such as CTRL-Pause, cursor positioning on the screen, changing terminal type, and so on.

For remote control of serial ports, Cisco has defined RFC2217 that defines commands for changing the serial port speed, querying the states of digital I/O signals, etc. Our devices implement most of these commands. For a list, see the online description of NVT at the above-mentioned website.

We extended the standard RFC2217 commands to include several GPIO (General Purpose Input Output) functions listed below. These functions can control the digital input and output pins of the I/O Controller. Our extension is not standardized; however, when we implemented this extension in 2001, no such standard was known to us.

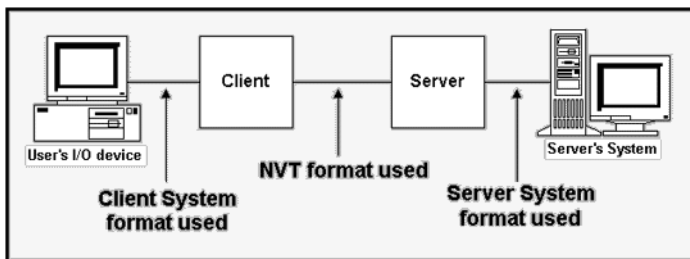

How does it work

The commands are control sequences in the TCP/IP data stream; the "FF" character starts the control sequence with a defined format. If the "FF" (255 decimal) character appears in normal data, it must be doubled at the transmitting side. The receiving side automatically converts double "FF" to single "FF". When both sides support NVT, the „FF" character always prefixes a control sequence.

| Supported NVT commands COM-PORT-OPTION - 44 (2C) | | |
|---|-----|--|
| Dec | HEX | Function |
| 0 | 00 | CAS_SIGNATURE |
| 1 | 01 | CAS_SET_BAUDRATE |
| 2 | 02 | CAS_SET_DATASIZE |
| 3 | 03 | CAS_SET_PARITY |
| 4 | 04 | CAS_SET_STOPSIZE |
| 5 | 05 | CAS_SET_CONTROL |
| 6 | 06 | CAS_NOTIFY_LINSTATE |
| 7 | 07 | CAS_NOTIFY_MODEMSTATE |
| 8 | 08 | CAS_FLOWCONTROL_SUSPEND |
| 9 | 09 | CAS_FLOWCONTROL_RESUME |
| 10 | 0A | CAS_SET_LINSTATE_MASK |
| 11 | 0B | CAS_SET_MODEMSTATE_MASK |
| 12 | 0C | CAS_PURGE_DATA |
| 50 | 32 | CAS_OPT_GPIO |
| 51 | 33 | CAS_SET_GPIO |
| 52 | 34 | CAS_SET_GPIOM |
| : | : | |
| +100 | +64 | ASC_ |
| 150 | 96 | ASC_OPT_GPIO |
| 151 | 97 | ASC_SET_GPIO |
| 152 | 98 | Not implemented, one way "answer" only |

Values up to 100 Dec = **Client >> Server**

Values over 100 Dec = **Server >> Client**

CAS_ request for the device to perform a command

ASC_ device response, command performed + confirmation

Commands start with <IAC><SB> (**FF FA**) and end with <IAC><SE> (**FF F0**).

Description of GPIO control commands – 50, 51, 52 (32 .. 34 hex)

For direct control of I/O pins, a fixed double byte GPIO sub-command is used – 50 or 51, preceded by the COM-PORT-OPTION 44 command and followed by the sub-option sequence.

Sub option 50 (32 hex)

Reading inputs, setting outputs bit by bit, reading the output register.

- **0 (00 hex)** – Request for input states, response includes input port state.
- **16 .. 23 (10 .. 17 hex)** – Set the output bit 0..7 to logic HIGH.
- **32 .. 39 (20 .. 27 hex)** – Set the output bit 0..7 to logic LOW.
- **48 (30 hex)** – Request for output states, response includes output port state.

Sub option 51 (33 hex)

Sets the value of the output port. In the response, the same value is returned (as read from the internal register).

Sub option 52 (34 hex)

Command used by the I/O Controller for automatic transmission of **input states, if there is a change** or after device power-up. This command does not expect a response, hence there is no value for 152 (98 HEX) in the table. The notification itself is actually an unsolicited response without a matching request. (Theoretically, this command can be used in NVT communication, too. It differs from sub option 51 in that the value sent to the port is modified with #X#Y#Z#W.) I/O Controller responds to this command with the same reply as for sub option 51, that is, the response number includes sub option 151.

The 52 (34 hex) command is often preceded by the “**FF FA 2C 32 00 FF F0**” sequence, which requests a value for the I/O Controller outputs. The response includes the I/O Controller output state (for example “**FF FA 2C 33 FF FF F0**”). After that, only the “**FF FA 2C 34 ZZ FF F0**” sequence is sent, where ZZ is the new value for the remote outputs.

Note: *To enable the input change notification function, it is necessary to set the range of transmitted inputs with “#T: Trigger AND mask”.*

- *To transfer all inputs, set #T=255.*
- *To disable the input change transfer function, set #T=0.*

Sub option 55 (37 hex)

This command is used by the I/O Controller for periodic transmission of input states. This command does not expect a response, therefore there is no value for 155 in the table. The notification itself is actually an unsolicited response without a matching request. It is an equivalent of the sub option 52 command for periodic transmission.

NVT control examples

Most NVT commands have a fixed length. So, for example, if a value has a 4-byte format, and the current setting can be read by “setting” a value of 0, this zero needs to be sent as 00 00 00 00 hex.

Setting the output byte

This command sets the output port to AA (10101010 bin).

```
<IAC><SB><COM_PORT_OPTION><CAS_SET_GPIO><(byte to output)><IAC><SE>
FF FA 2C 33 AA FF F0
```

As a response, the following sequence confirms the port settings:

```
<IAC><SB><COM_PORT_OPTION><ACS_SET_GPIO><(byte to output)><IAC><SE>
FF FA 2C 97 AA FF F0
```

Reading the inputs

Request for the input value (XX) at GPIO.

```
Outgoing sequence: FF FA 2C 32 00 FF F0
I/O Controller returns: FF FA 2C 96 XX FF F0
```

Reading the outputs

Request for the current value (XX) of the output register that controls the output pins.

```
Outgoing sequence: FF FA 2C 32 30 FF F0
I/O Controller returns: FF FA 2C 97 XX FF F0
```

Resetting the D5 output

Request to set one output bit to logic LOW, without changing other output bits.

```
Outgoing sequence: FF FA 2C 32 25 FF F0
I/O Controller returns: FF FA 2C 97 DF FF F0
```

where DF is the actual output port value (also depends on the previous port state). I/O Controller changes only one bit but the response contains the entire port value.

Input state change notification

Unsolicited notification that reports a change at the inputs of the I/O Controller through an established TCP connection. It can start with the FF FA 2C 32 00 FF F0 sequence – see the more detailed description.

```
Outgoing sequence: none
I/O Controller sends: FF FA 2C 34 XX FF F0
```

where XX is the current value at the input port.

Note: *The function works similarly to the incoming serial port data. Thus, in the TCP Client/Server mode (IP address of the remote side is specified) with NVT enabled, the device attempts to establish a connection and send the input change information whenever a single byte of serial data is received or any digital input changes. After establishing the TCP connection, only the current input state is sent, NOT the whole history of changes (while the connection was closed).*

Changing the RS-232 / RS-485 serial port baudrate

Request to change the serial port communication speed.

The current port speed can be retrieved by sending the value of **00 00 00 00** (the response contains the current speed). If any other value is sent, the server uses it to set the serial port speed. When converted to a decimal value, the value directly indicates the communication speed in Bauds.

Outgoing sequence: **FF FA 2C 01 00 00 00 00 FF F0**
I/O Controller returns: **FF FA 2C 65 00 00 25 80 FF F0**

Converting **00 00 25 80** to decimal, the current speed of **9600 Bd** is obtained.

Keep Connection

To keep the connection alive and avoid the 50 second inactivity timeout, use the “**K: Keep connection**” option in the device setup. NVT must be enabled for this to work. The connection is kept alive by sending a NOP command (**FF F1**) **from the I/O Controller approximately every 5s**.

If port sampling is enabled with the #T: Trigger AND mask, the device sends the I/O keep command (“**FF FA 2C 37 ZZ FF F0**”) instead of the NOP command (see #K, #L, #M, #N).

Are You There?

The Telnet standard supports an “Are you there” request to determine if there is a live device at the other side. Standard Unix devices usually reply with “Yes”.

Outgoing sequence: **FF F6**
I/O Controller returns: <WEB51 HW XXX SW XXX SN XXX #0F *OvErr *ParErr *FIErr>

Individual XXX values are often proprietary, or can be left out in case of error messages. Sample reply: <**WEB51 HW 4.5 SW 2.3 SN 01A03B #01**>